



Paulmann

### Safety Instructions

1, 2, 3, 4, 5, 6, 7, 8, 28, 33, 34



Info

[www.paulmann.com](http://www.paulmann.com)

Paulmann Licht GmbH  
Quezinger Feld 2  
31832 Springe  
Germany

[www.paulmann.com](http://www.paulmann.com)

Art.-Nr. : 667.46  
(+MA 326) PUP 12/18

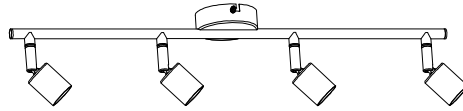

Incl.

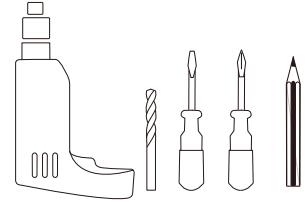

A

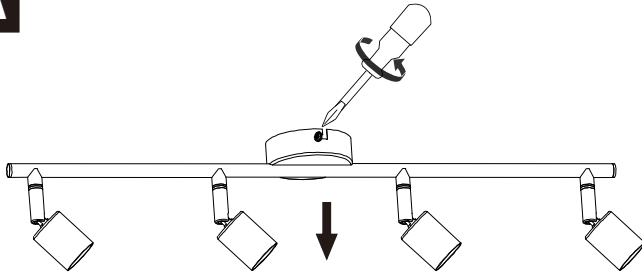

B

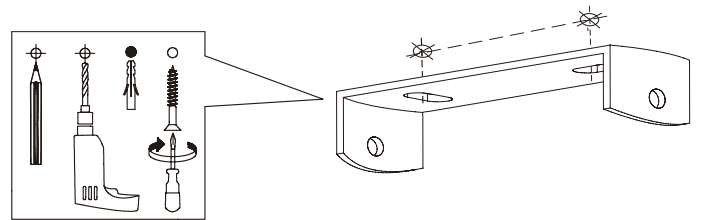

C

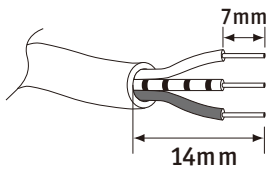

230V

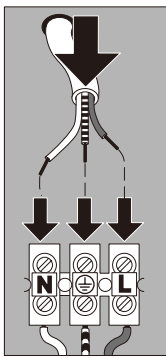

D

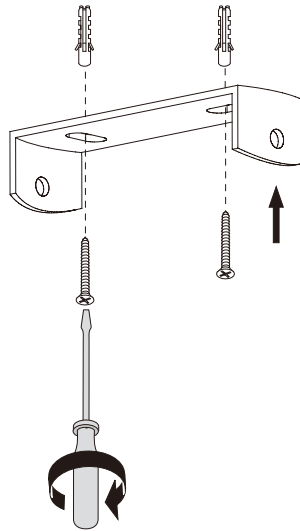

E

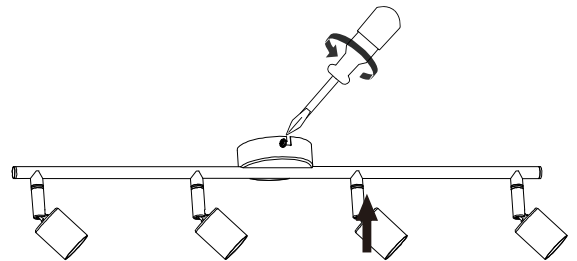

F

