

Safety Instructions

1,2,3,4,5,6,8,12,16,17,18,
19,20,22,24,29,30,31,32,
33,34



Info Hotline



+49 (0) 5041 998 389

Mon. - Do. 7⁰⁰ - 20⁰⁰
Fr. 7⁰⁰ - 17⁰⁰

Paulmann Licht GmbH
Quezinger Feld 2
31832 Springe
Germany

www.paulmann.com

Art.-Nr.: 954.81
954.82
(+MA326)PH03/17

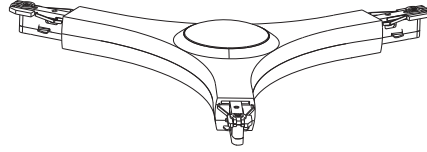

1x



1x



incl



A



Safety
Instructions
Nr. 3,4,5,6

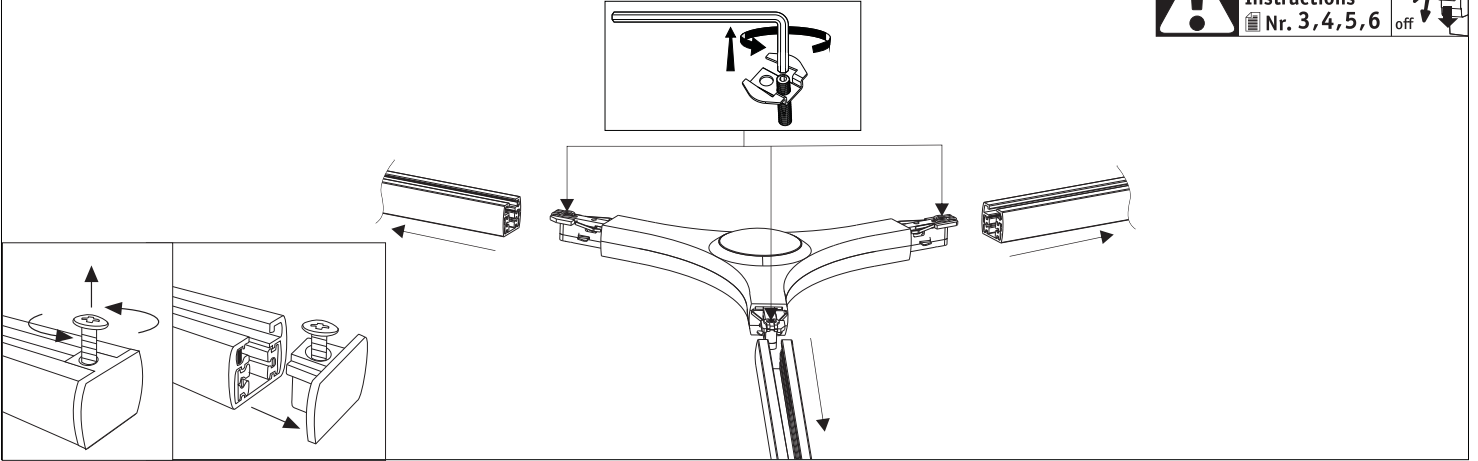

B

